

# ENCATA

Engineering services and pilot-scale production

- ✓ Hardware design based on the Customer's business vision
- ✓ Engineering consultancy at all product development stages
- ✓ Prototyping and pilot-scale production

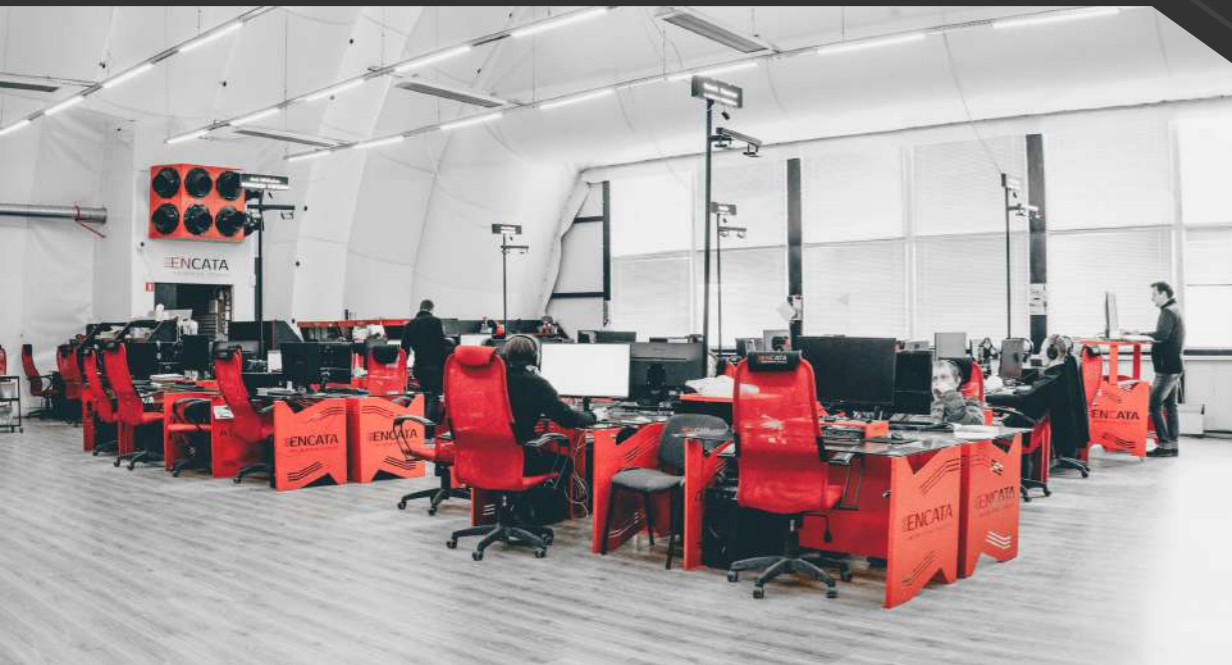

- ✓ Engineering and design services - from your business idea to pilot batch
- ✓ Electronics design - PCB, firmware, server backend
- ✓ FEA and CFD simulations
- ✓ In-house manufacturing - from 3D-printing to full 5-axis CNC machining

# EnCata company in numbers

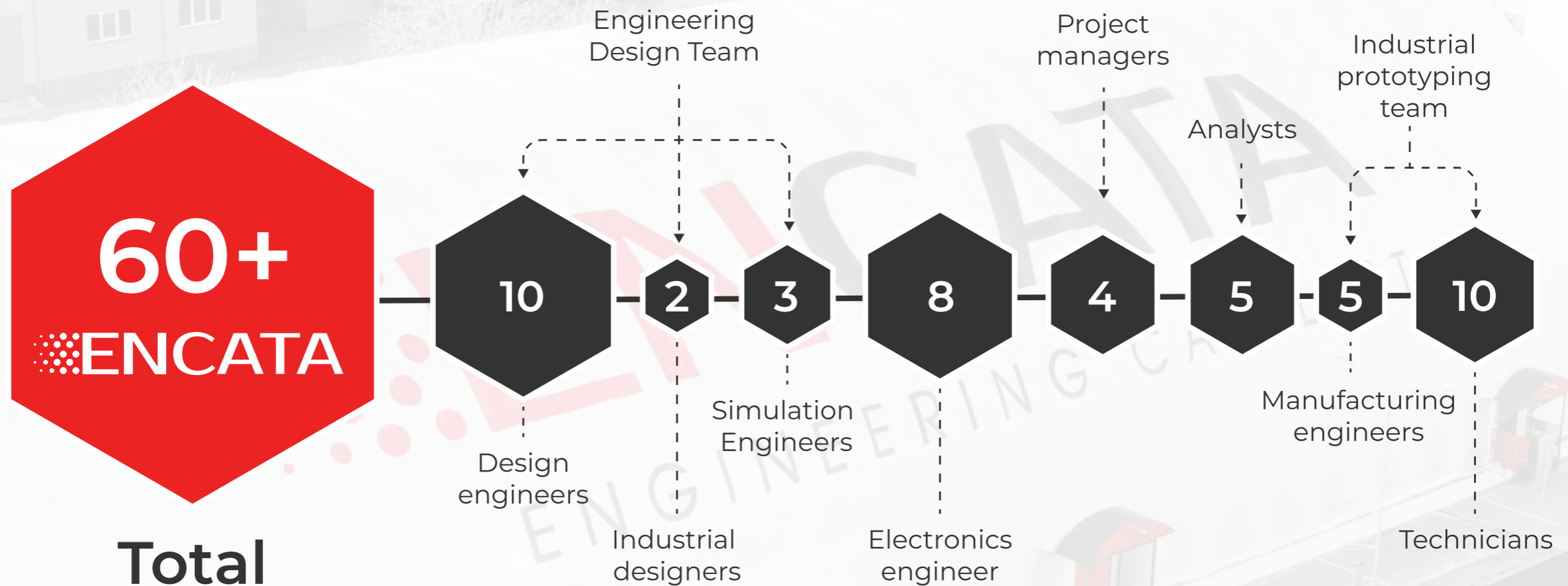

**Total**

- EnCata was founded in 2006 as a product company. It specialized in industrial air purification equipment and electronic devices manufacturing.

- In 2017 EnCata became the member of Hi-Tech Park in Belarus and began providing engineering services.

- EnCata is structured in 7 different departments, whereby 5/7 are comprised of engineers

- Company employs 7 PhDs (Physics, Nanotech, Chemical Technology, Mech.Engineering)

- All the Project Managers have either BSc/BEng or MSc/MEng and have previously worked as engineers

# Technology Readiness Levels (TRL) according to NASA

We are able to conduct R&D and deliver [business + technology] research services to our clients

- ▶ TRL-1
- ▶ TRL-2

IDEA: basic principles observed  
 Product or technology concept formulated



- ▶ TRL-3
- ▶ TRL-4

Applied / Lab research  
 Lab-scale prototype (proof of concept)



Design engineering and prototype development including design-2-manufacture

- ▶ TRL-5
- ▶ TRL-6
- ▶ TRL-7

Sub-system prototypes. First tests in the required environment  
 α Prototype Tests. Performance is close to the expected  
 β Prototypes pass field tests. Pre-commercial demonstration

EnCata is capable of delivering batch production

▶ TRL-8

DFM (design for manufacturing. Prototype improvements are finished, design documentation is drawn up and finalized  
 Batch production and Market tests

EnCata provides engineering consultancy services concerned in mass-production for China and Eastern Europe

▶ TRL-9

Market launch. Mass production.

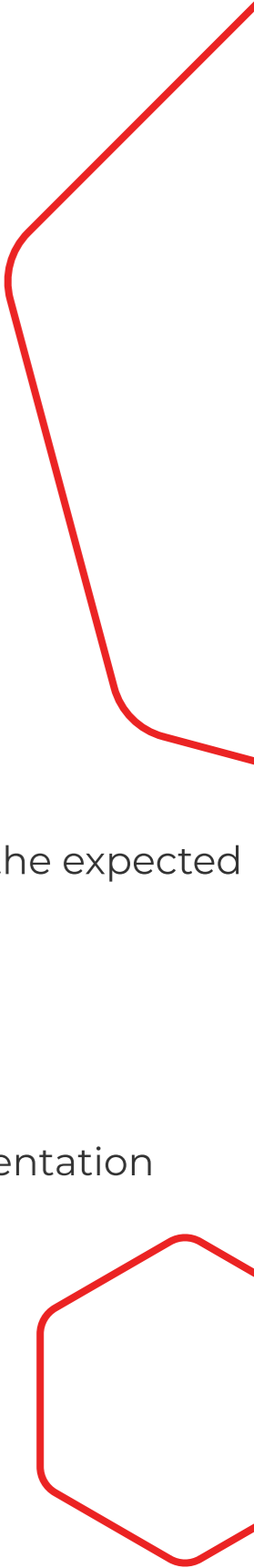





SMART CITY



FILTRATION



CONSUMER GOODS

AIR  
AND  
PURIFICATION

# HUMIDIFIER

Personal desktop device for creating favorable living conditions at and around the workplace.

Functions: cleaning, humidification, aromatization, ionization (optional), cooling (optional) air. Filters and aromatizers must be included into the standard equipment.



The user can control it via a phone app. There are diodes (lights) and a power button on the front panel.

Operating time in humidifying mode: up to 8 hours

Dimensions: 123\*123\*223mm

Noise level: < 40 dB



## ENCATA'S Role



Industrial design creating



Engineering documentation development



Prototype case making: laser printing, grinding and painting

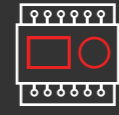

Developing software for a mobile application

## Technology readiness level



## TECHNOLOGIES



3D Modeling



High level programming language

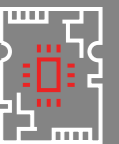

Prototypes of printed boards

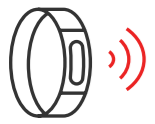

CONSUMER  
GOODS



MEDICAL  
DEVICES



IoT

# SMART BRACELET

If a person becomes ill, PAC Sputnik will monitor their vital signs and, if needed, will summon an ambulance. The device can save a person's life, when there is a high chance of recurrence after a heart attack or stroke.

An elderly person will also receive timely assistance, as Sputnik notifies doctors and relatives of health deterioration.



The device is controlled via the web/application "Sputnik".

PAC dimensions (LxW): 7x5 cm.

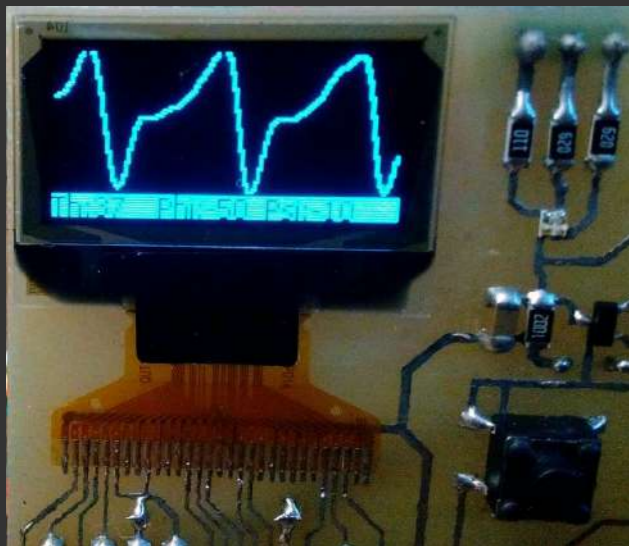

Operating time of the device: 1 month.

NOR Flash memory capacity: 256 MB

Oled display resolution: 128x64 pixel

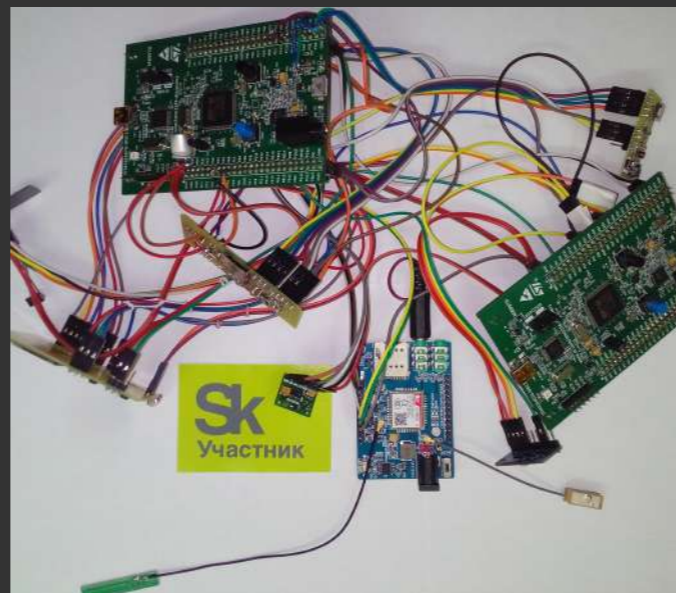

## ENCATA'S Role



Industrial design making



Engineering documentation development

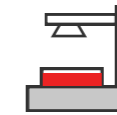

Prototype case making: laser printing, grinding and painting

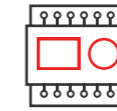

Developing software for a mobile application

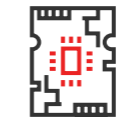

Manufacturing multilayer and printed circuit boards

## Technology readiness level

3

7

## TECHNOLOGIES

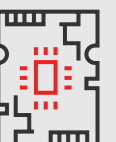

Prototypes of printed boards





IoT



CONSUMER GOODS

# SMART PLUG

A precise dispensing device is required for real-time alcohol consumption, integration with automated systems and providing customer self-service functions in the establishment.



The device addresses the issue of cashless payments in establishments. For the client to pay for drinks, NFC technology is embedded. The procedure takes up no more than 5 seconds.

Convenience: one smartphone can replace one or more plastic cards.

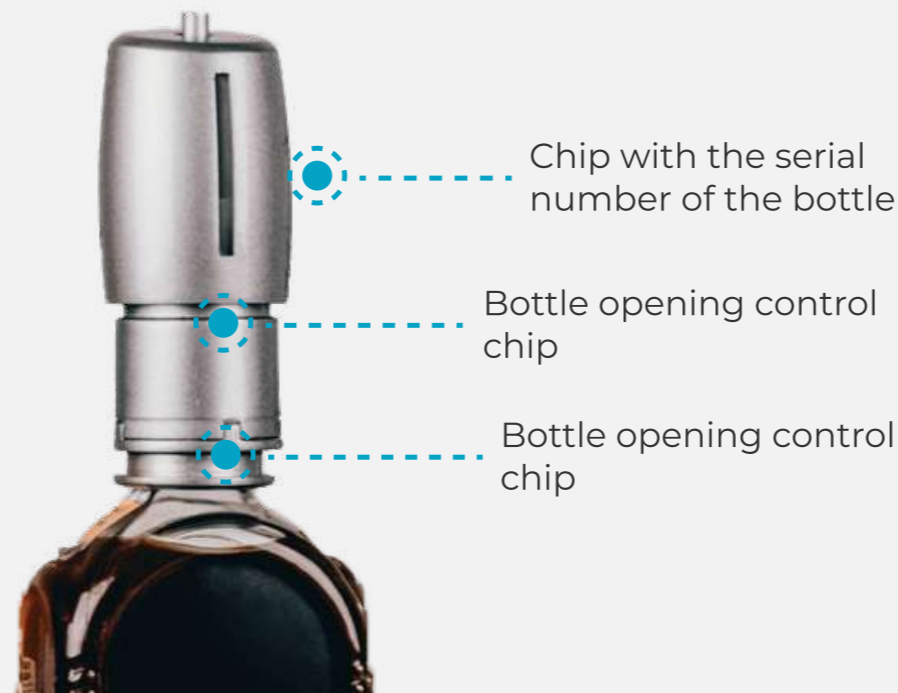

## ENCATA'S Role



Industrial design making



Engineering documentation development



Prototype case making: laser printing, grinding and painting

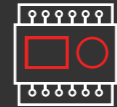

Developing software for a mobile application

## Technology readiness level



## TECHNOLOGIES



Injection molding



JAVA 11



NFC

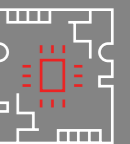

Electronics design



IoT



SMART CITY

# RAT TRAP

The trap is designed to record and communicate information about the presence of rodents at the device's location. There is a rodent bait inside the trap. When a rat enters the trap, a sensor is activated, and a message is sent out with information on the trap's status and a counter of registered rodents. The device runs on the NB-IOT network, which provides a long battery run.



The device is controlled by a server. When a rodent is detected in the trap, the trap number is sent to the server.

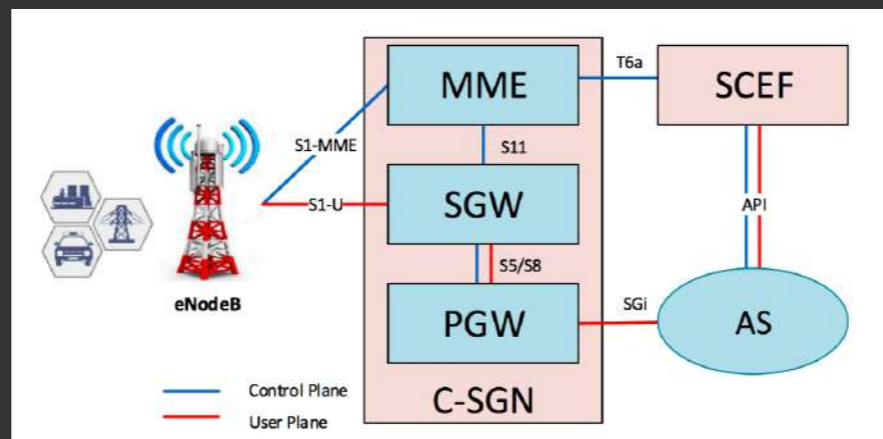

Using NB-IOT technology  
Device dimensions  
(LxWxDG):205x105x154 mm

Operating time: more than 1 year (using 6V 4 A4 batteries)

## ENCATA'S Role



Engineering documentation development

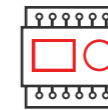

Developing software for a mobile application

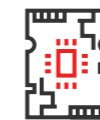

Manufacturing multilayer and flexible printed circuit boards

## Technology readiness level



## TECHNOLOGIES

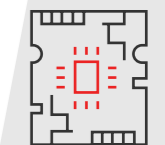

Electronics design



SMART CITY



CONSUMER GOODS

# Zephyr LOCK

Zephyr Lock is a new electronic system for remote control of locks.

It can be done using a web interface or a mobile application. The lock can also be controlled by RF and NFC.

To operate the lock, one might use RF or NFC.

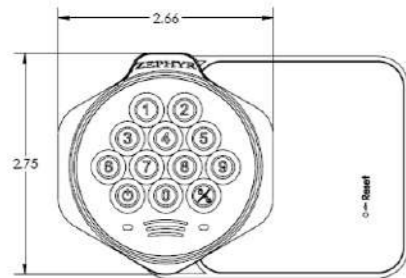

The device is controlled via a web interface or mobile application. The mobile app has been developed for iOS and Android. The Desktop app communicates with the card reader and user card records.

Device operating time: from 6 months to 1 year (between battery changes).

Device dimensions (LxW): 2.75x2.66 cm

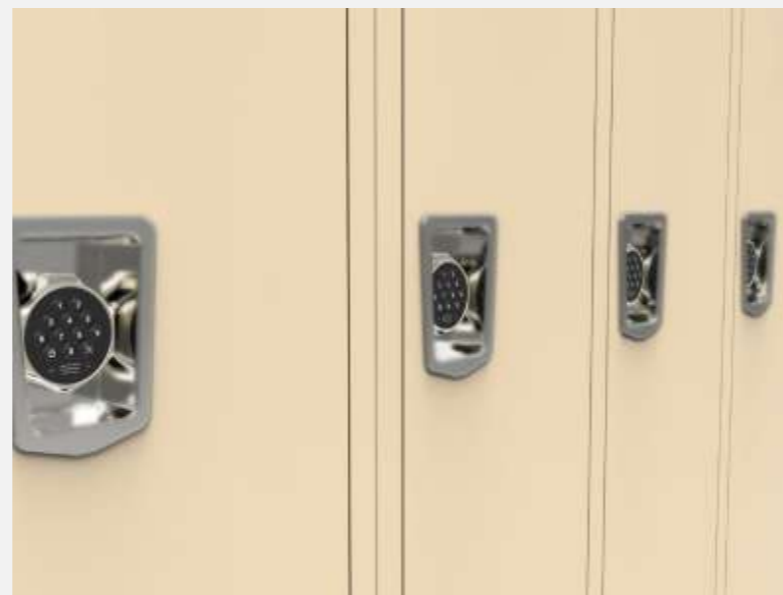

## ENCATA'S Role



Engineering documentation development



Prototype case making: laser printing, grinding and painting

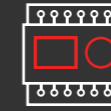

Developing software for a mobile application

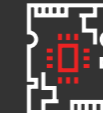

Multilayer and flexible printed circuit boards production

## Technology readiness level



SMART CITY

## TECHNOLOGIES

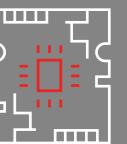

Electronics Design



# Contact information



+9 (955)-553-448-23



info@encata.net



encata



www.encata.net

